

Dual safety
Auto reverse /
Built in Safety Beam



Reliability
Passed million
cycles test



High Efficiency

■ Motor [60w/90w]



- Long durability and quiet operation
- Built in motor locking device(optional)
- High efficiency worm gear motor

■ Controller



- Self monitoring system & digital setting
- Built in safety beam terminal(optional)
- Suitable for 60w & 90w motor
- Adjustable partial opening width & opening hold time
- Failsafe safety reverse feature

■ Idle pulley



- Low noise design
- Adjustable belt tension

■ Timing Belt



- Low noise & Smoother quality
- Long durability teeth belting



■ Hanger Roller [standard type]

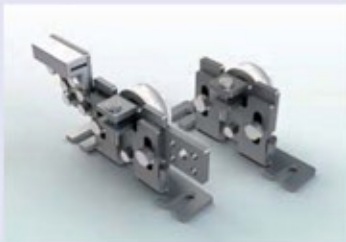

- Optimized low running noise and strong durability design
- Derailment prevention structure
- Door vertical height adjust design

■ Hanger Roller [Heavy duty type]



- Optimized low running noise and strong durability design
- Derailment prevention structure
- Door vertical height adjust design

■ Transformer



- Transformer coupling with on/off switch
- Input - AC110V~220V(50~60Hz)
- Output - AC 24V/3A

■ SMPS



- Input - AC100V~250V
- Output - 5V/1A , 28V/5A
- Slim and lighter than the existing linear method.
- Highly efficient, and has low electricity consumption while stand by



Technical specifications 60W

TYPE	Single leaf	Double leaves
Model	RADOS-100F-S(60W)	RADOS-100F-D(60W)
Power supply	AC 220V(50~60Hz)	
Controller	Micro-Processor Control	
DC gear motor	DC 24V 60W Gear Motor	
Drive	S8M Timing Belt	
Maximum door weight	120Kg X 1	80Kg X 2
Opening speed	350 mm ~ 1000 mm / sec (Adjustable)	
Closing speed	150 mm ~ 850 mm / sec (Adjustable)	
Min~Max clear width	700 mm ~ 1200 mm X 1	700 mm ~ 1200mm X 2
Hold open time	0~20 sec	
Safety function	Safety reverse	
Ambient temp	-30°C ~ +50°C	

Technical specifications 90W

TYPE	Single leaf	Double leaves
Model	RADOS-100F-S(90W)	RADOS-100F-D(90W)
Power supply	AC 220V(50~60Hz)	
Controller	Micro-Processor Control	
DC gear motor	DC 24V 90W Gear Motor	
Drive	S8M Timing Belt	
Maximum door weight	150Kg X 1	120Kg X 2
Opening speed	350 mm ~ 1000 mm / sec (Adjustable)	
Closing speed	150 mm ~ 850 mm / sec (Adjustable)	
Min~Max clear width	700 mm ~ 1500 mm X 1	700 mm ~ 1500 mm X 2
Hold open time	0~20 sec	
Safety function	Safety reverse	
Ambient temp	-30°C ~ +50°C	

Rail Profile

Aluminum Profile

Various design of rail for different applications
Suitable for both Industrial heavy door & commercial door



■ Concealed F Type



TYPE	SINGLE	DOUBLE
MODEL	RADOS-100FA-A	RADOS-100FA-D
MOTOR	DC 24 V 60W/ 90W	
Door Weight	120Kg	80Kg x 2
OPTION	LOCK MOTOR / NONLOCK MOTOR	



■ Wall mount WA Type



TYPE	SINGLE	DOUBLE
MODEL	RADOS-100WA-S	RADOS-100WA-D
MOTOR	DC 24 V 60W/ 90W	
Door Weight	120Kg	80Kg x 2
OPTION	LOCK MOTOR / NONLOCK MOTOR	



■ Wall mount WB Type

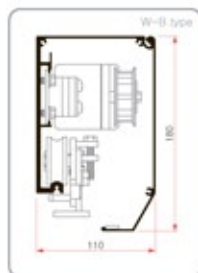

TYPE	SINGLE	DOUBLE
MODEL	RADOS-100WB-S	RADOS-100WB-D
MOTOR	DC 24 V 60W/ 90W	
Door Weight	120Kg	80Kg x 2
OPTION	LOCK MOTOR / NONLOCK MOTOR	

Telescopic System



Feature

The entrance space can be fully utilized even with the limited and narrow space. Since two doors are simultaneously opened/closed toward same direction, the speed of opening/closing is fast, and the other space can be used as much as possible. It is available to design not only double, but also, triple and quadruple type.

TYPE	SINGLE	DOUBLE
MODEL	RADOS-300-S	RADOS-300-D
MOTOR	DC 24 V 60W/ 90W	
Door Weight	80Kg x 2	60Kg x 4
OPTION	LOCK MOTOR / NONLOCK MOTOR	

Drawing

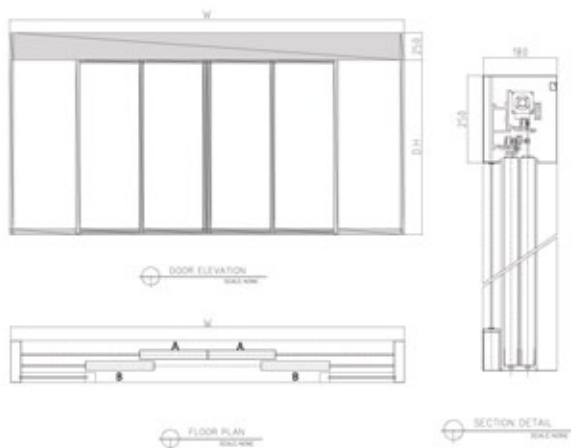

Detailed view

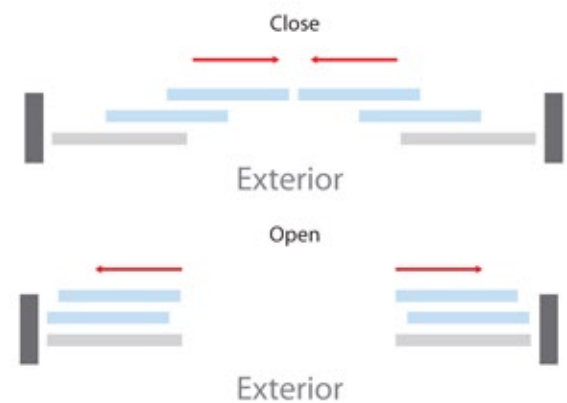



Feature

This is the best automatic door suitable for the main gate of large supermarkets, or apartments or villas where unmanned security is necessary as well as general buildings. It is designed to expand the open area in case of fire or emergency to easily escape or move large size freight for safer and more convenient usage. It can be used as a sliding automatic door in normal situations. In case of fire or emergency, the door can be pushed to the fixed window and opened by 90 degree angle. So it can be conveniently used according to the purpose.

TYPE	SINGLE	DOUBLE
MODEL	RADOS-500-S	RADOS-500-D
MOTOR	DC 24 V 60W/ 90W	
Door Weight	120Kg	80Kg x 2
OPTION	LOCK MOTOR / NONLOCK MOTOR	

Drawing

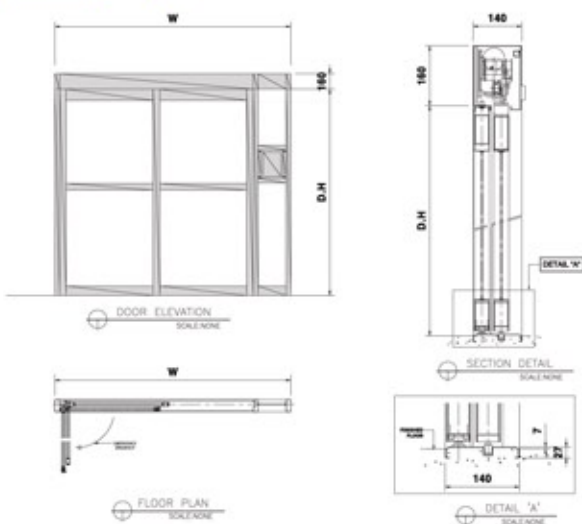

Detailed view

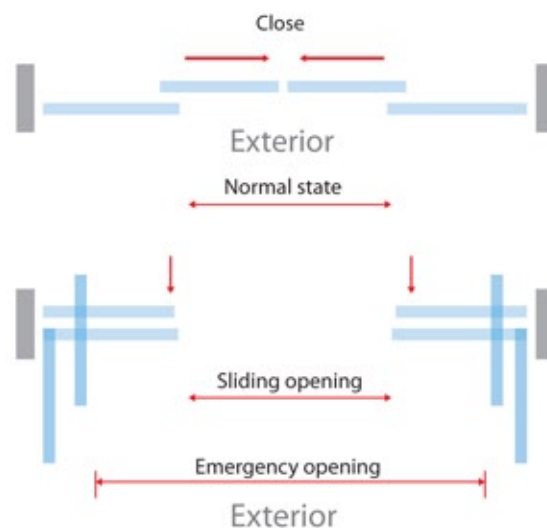



Feature

If installed at the entrance of a building, it forms a round-type curve and magnificent space beauty.
 - The durability is high and the operation is smooth.
 Since it raises the effect of heating/cooling, it can maximize the efficiency of heat management.

TYPE	SINGLE	DOUBLE
MODEL	RADOS-700-S	RADOS-700-D
MOTOR	DC 24 V 60W/ 90W	
Door Weight	120Kg	80Kg x 2
OPTION	LOCK MOTOR / NONLOCK MOTOR	

Drawing

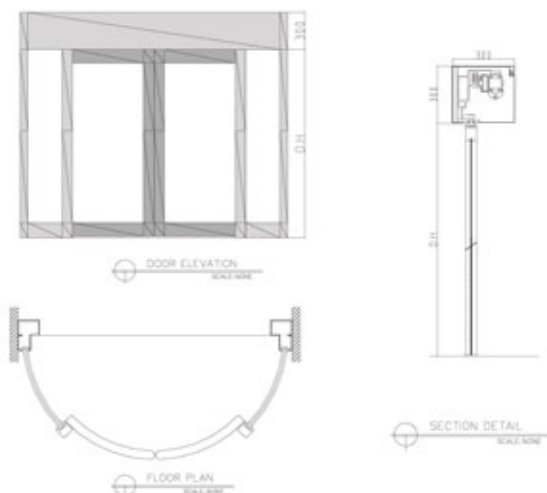

Detailed view

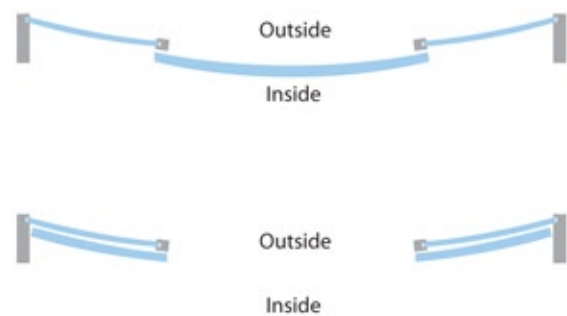

Heavy duty industrial System



Feature

This is an automatic door which makes heavy weight door opened/closed. It is mainly used in factories and warehouses. With micro processor control, it is designed to block irregular external conditions such as external wind pressure, insulation and noise. The multi-functional opening/closing function can be adjusted according to the site. This is an essential automatic door for logistics and factory automation to increase productivity, and an industrial automatic door suitable for large warehouses and buildings.

TYPE	SINGLE	DOUBLE
MODEL	RADOS-900-S	RADOS-900-D
Door Weight	200Kg	120Kg x 2
OPTION	LOCK MOTOR / NONLOCK MOTOR	

Detailed view

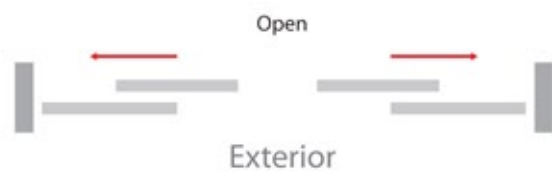
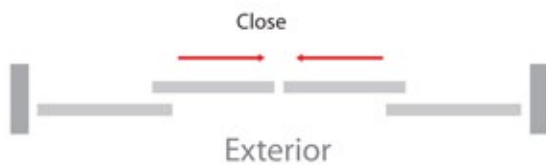

Wiring diagram & Controller Setting

Automatic door wiring diagram

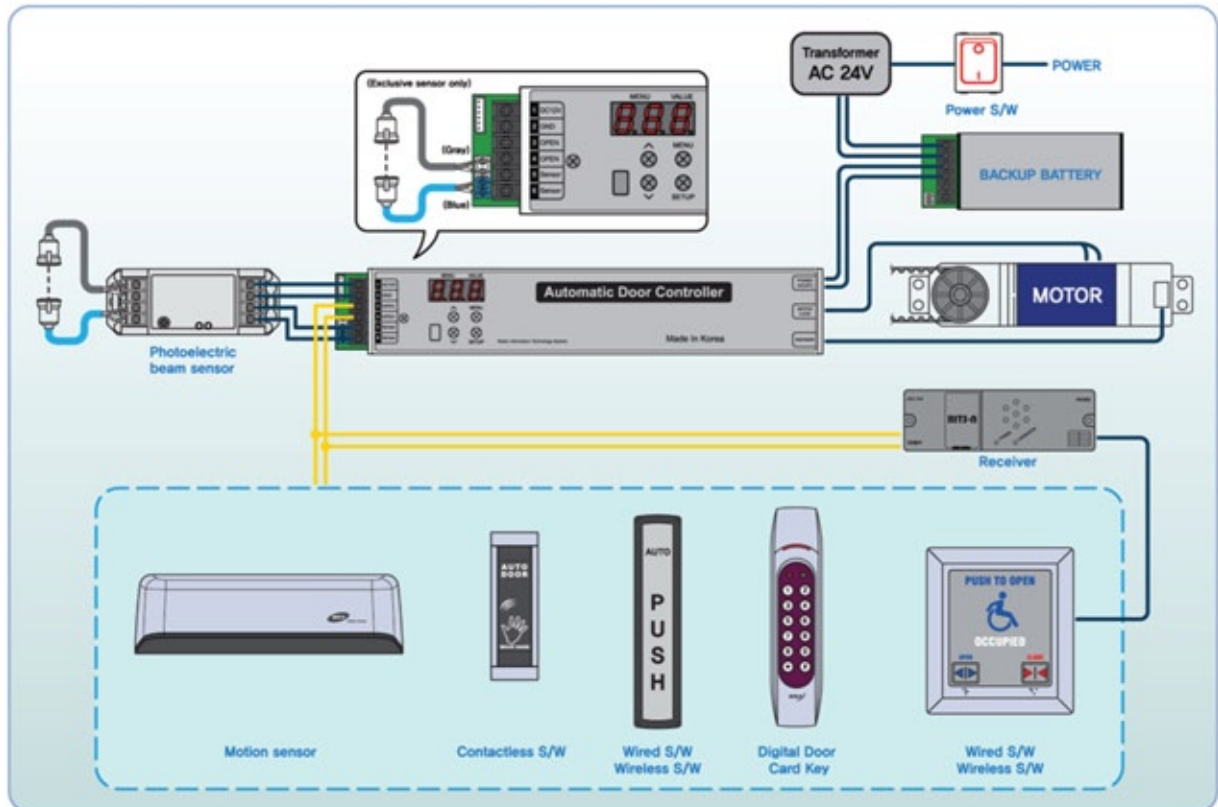

Automatic door controller Function and Setting Guide

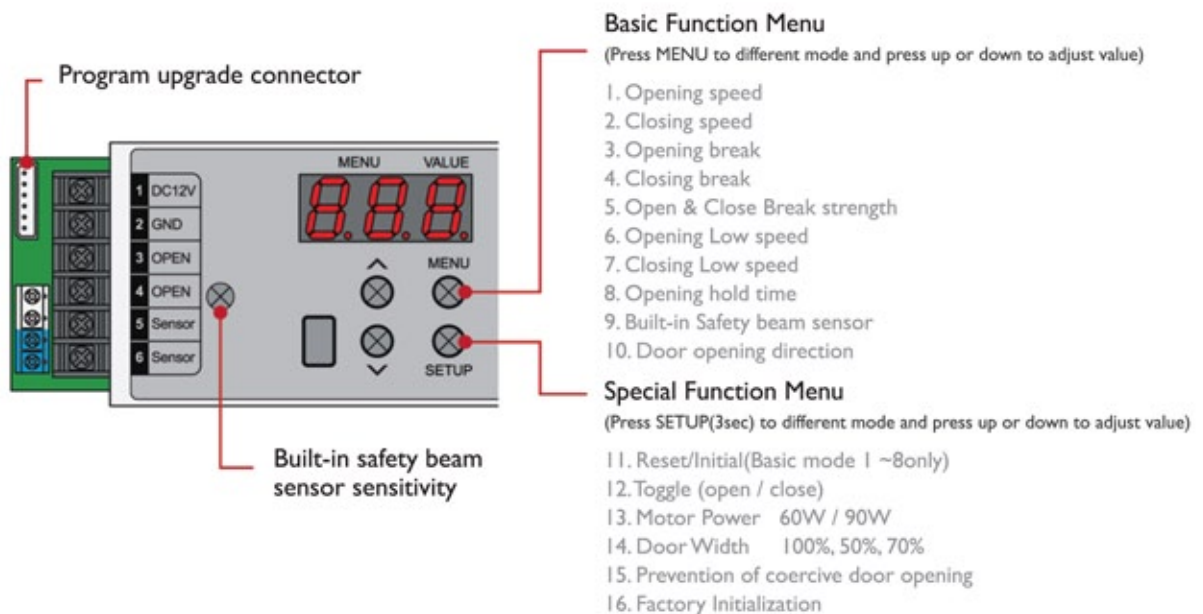

Function switch & Back-up battery

Function switch

Function switches for automatic door operator



Doors operate in full open mode



Door operate in half open mode



Fully automatic mode
-For external & internal



Semi automatic mode
-No entry from external



Hold open mode



Operator locking mode

Back-up battery



Back-up battery power will allow doors to open when power failure, in case of emergency cases.

Specification	Input power	DC30V, AC24V
	Output power 1	DC28.6V (When input power is 30V)
	Output power 2	DC18V ±5% (During battery output)
	Output current 1	10A Max (During input power approval)
	Output current 2	0.6A Max (When using battery power)
	Charged voltage	Input power of at least DC28V
	Recharge time	Recharges for at least 120 minutes
	Battery time	Three minutes & 10 times
	Response when input power is OFF	Activation within 3 seconds
		 Contact point output is set as available or unavailable when input power is OFF. Firefighting input power is set as available or unavailable.

Total Solution for



Microwave motion sensor

The microwave motion sensor is installed at an automatic door and senses the motion of a man or an object to open and close the automatic door.



Wire/Wireless touch switch

High-sensitivity FM wireless touch switch designed to open and close an automatic door
This switch is to open and close an automatic door.



Contactless switch

The proximity sensor is to open and close an automatic door when a hand is close to the front.



Photoelectric beam sensor

The safety sensor opens and closes again an automatic door if there is an object that is sensed in an instant when it is operated.

Automatic Doors



Automatic door controller

As a self-error monitoring controller, it is smart and reliable to drive different power motor without changing of controller



Digital door key

The digital door key is designed to automatically open the door by pressing secret access numbers or making an ID card close to it at every entrance through an automatic door.



Wire/Wireless Switch for the physically challenged

This automatic door switch is installed at the entrance and in the inside of a toilet for the physically challenged to automatically open and close the door.

FM Transmitter / Receiver

Multi-purpose, high-sensitivity and high-performance FM transmitter and receiver to control automatic shutter, sliding door, overhead door, cylindrical motor, and other similar devices from a distance

